

WYTYCZNE PROJEKTOWE  
DLA PAWILONU P-1  
PAWILON P1  
2,5 m x 4,0 m  
H = 2,5 / 3,0 m

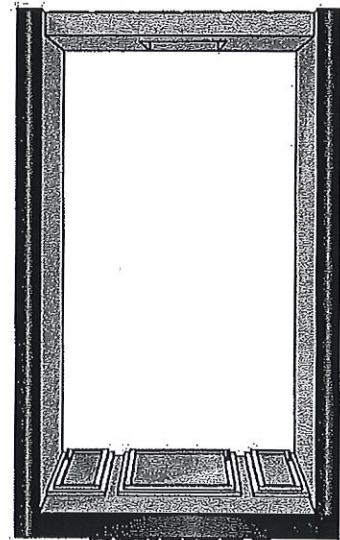

*Handwritten signature*

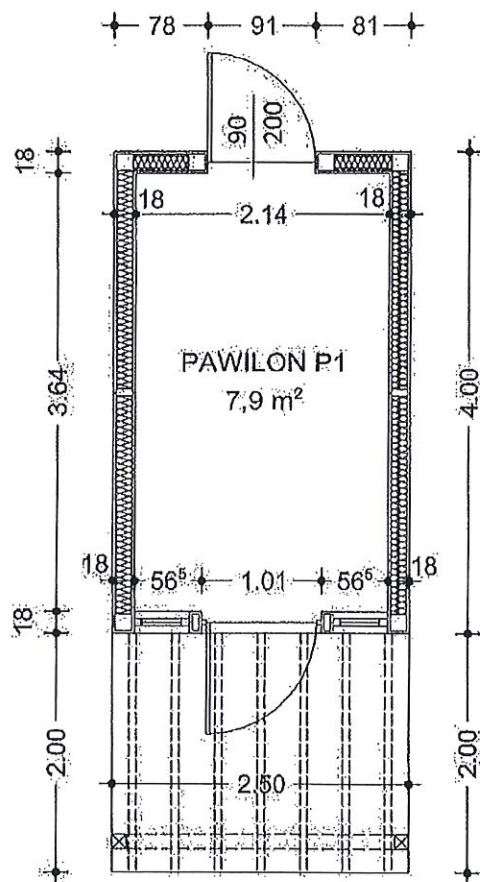
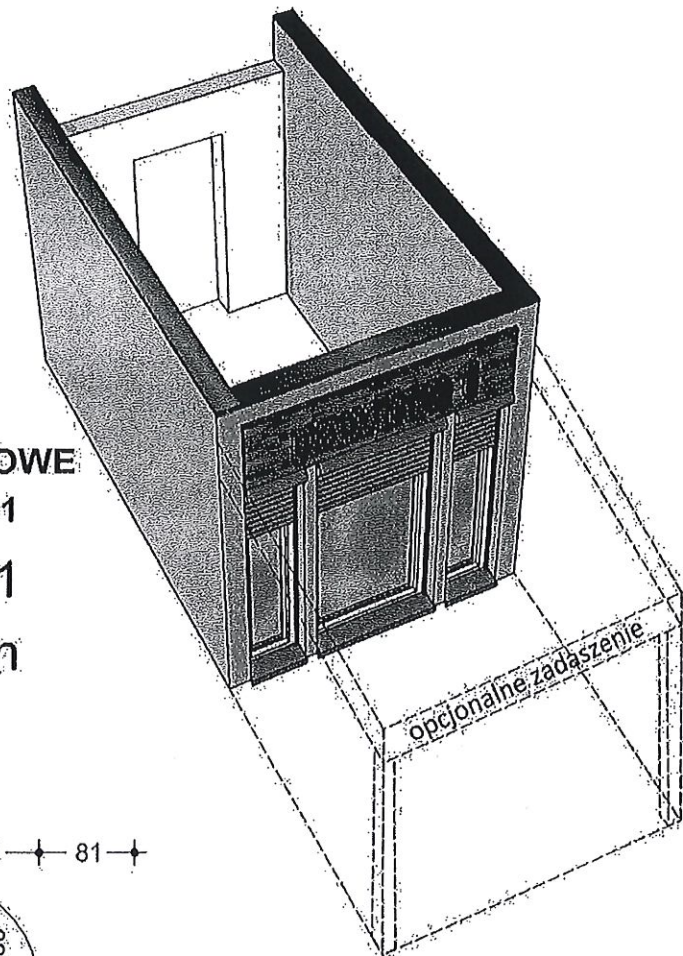
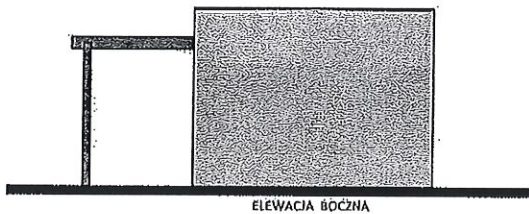
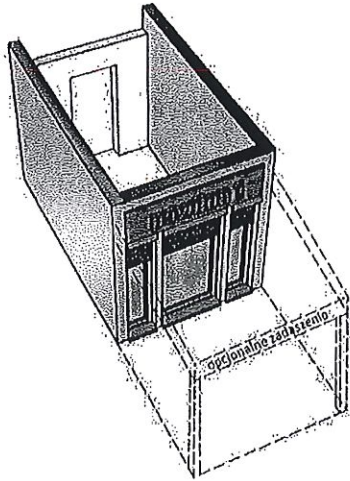

ELEWACJA BOCZNA

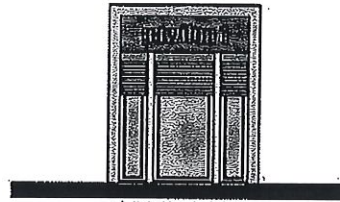

ELEWACJA FRONTOWA

78 91 79

WYTYCZNE PROJEKTOWE  
 DLA PAWILONU P-1  
 PAWILON P2  
 2,5 m x 3,0 m  
 H = 2,5 / 3,0 m

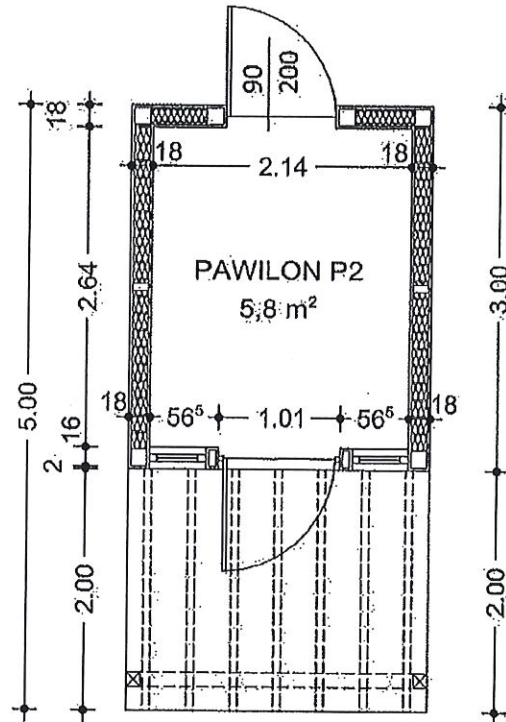

*[Handwritten signature]*